



Head Quarter & Ataevler

Durmazlar has aimed continuous development since 1956

Owes one of the world's most contemporary production plants in the production technology business .3 different plants oriented to different product families, 1000 dedicated employees and 150.000 m2 footprint.

In order to offer solution according to clients' needs and enriching the quantity and quality of its own patent rights; long experienced Engineering Department transformed to Durma Research & Develepment Center has opened in the year 2010. Designed and engineered with modern technics; its products are equipped with proven quality components to precisely fulfill your requirements. We serve "accuracy, speed, flexibility, durability, reliability and advanced technology" with high performance/price ratio. Worldwide Durma distributors and technical support network assures perfect support to our clients.

With its 55 years of experience, its product quality, innovative solutions Durma gives importance and cares you with proactive approach. We thank all our clients to hold us at the top segment of the world brands.



Ataevler



Laser Factory



Başköy Factory

DURMA PLASMA CUTTING MACHINES

Plasma machines offer quality, efficiency, lower cutting cost and wide range of cutting of mild steel, stainless steel and aluminium.

High performance machines provide the best cutting angles and long consumable life for the customer's needs by using the world class plasma equipments and control systems.

PL Series

Rail Type Plasma Cutting Machine

High Definition Cutting for Heavy Duty Productivity

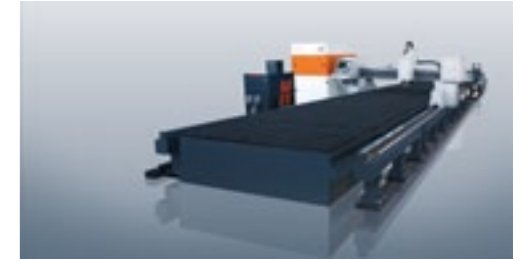

PL-C Series

Compact Plasma Cutting Machine

High Definition, Flexible, Small Footprint Cutting Solution

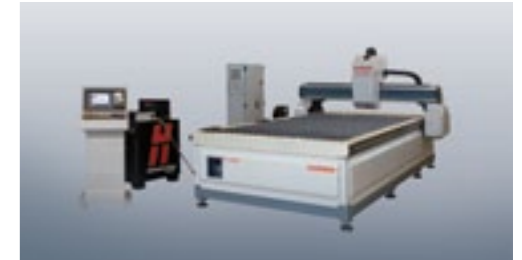

PL SERIES

Durma uses only the best in components which include a Siemens motion control system and a Hypertherm supply source. A strong effort has been made to provide the following;

- *Best cut angle*
- *Best edge quality*
- *Precise & fast positioning*
- *Long consumable life*
- *Easy programming*
- *Easy setup*
- *Reliability*
- *Energy efficient*
- *Clean operation*

The PL Series is built manufactured as a true precision machine tool. These high performance plasma cutting machines are designed to cut a wide range of mild steel, stainless steel and aluminum. The PL is equipped with well known, reliable, and readily available components.

High positioning speeds, accelerations and automatic torch height control provide the best in high quality efficient cutting. The 2D cutting system is available in standard as well as custom lengths and widths.

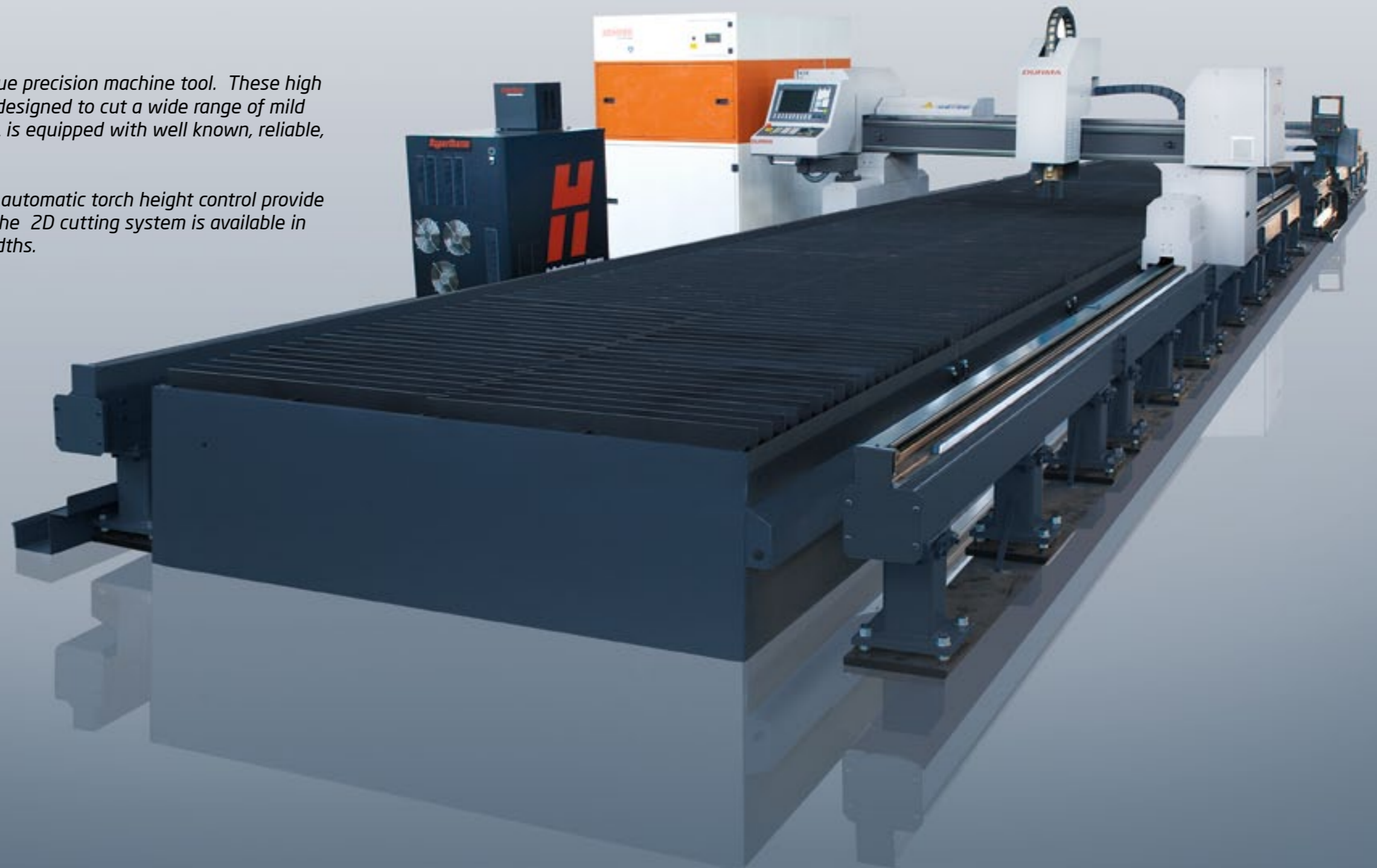

PL-C SERIES

The PL-C (compact) Series unitized frame concept, and the PL series which utilizes system where the table is independent of the two guide rails which are floor mounted.

Dual precision rack/pinion guiding for both the Y1, Y2 axis and the gantry (X axis), which houses the cutting torch. The heavy duty machine frame is welded and stress relieved. A synchronized dual side backlash free drive system with high accuracy planetary gears provides for high quality and accurate cutting. The tables are partitioned and zoned for efficient removal of dust. Manual and programmable beveling and oxyfuel cutting heads are several optional features that are available.



Plasma Source

HPR Series is used as the plasma source. It is available in 130,260, and 400 amp capacities. Manual or Automatic gas control consoles are available to assure the best cutting gas ratio is achieved. For labeling and identification purposes, a marking feature is included. The system is supplied with laser locating device. A laser beam is used to locate the x and y coordinates of the sheet. This allows the cutting axis to know exactly where it is with respect to the sheet. Faster setup and more accurate cutting.

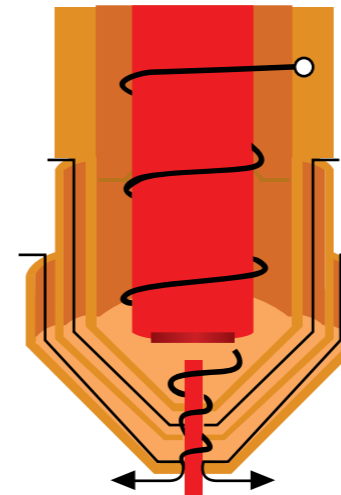

Work Piece



Hydefinition Cutting

Patented HyDefinition technology aligns and focuses the plasma arc, improving arc stability and energy for more powerful precision cutting. Narrow kerf width enables fine feature cutting and minimizes material waste. Robust, dross-free cutting minimizes part clean-up. Repeatable cut-edge quality eliminates scrap and rework. Improved hole and internal shape cuts rival laser quality at lower cost.



Torch Height Control

Hypertherm's X-Y Command THC is a torch height control system designed for plasma cutting applications on an X-Y cutting table. The system uses the plasma arc voltage to control the physical stand-off (distance) between the torch and workpiece during plasma arc cutting. Initial height sensing (IHS) is accomplished by ohmic contact sensing or by a limited force stall detection method.

Also the used equipment called Breakaway protects the plasma torch against crashing by sending an interrupt signal.



CNC Control Unit

The SINUMERIK 840Di is a fully PC-integrated numerical control system for up to 20 axes, interworking with the SINAMICS S120 drive system.

The control has open hardware and software functions and is ideally suited for users requiring distributed automation solutions with regard to PLC I/Os and drives and/or prefer a fully PC-integrated control system.

Durma has a own plasma software on Sinumerik controller. The operator can load the operation parameters to the power supply easily. Some simple shapes can be loaded from the included improvable library. The cutting operations is shown on the screen during cutting. Controller can be connected to the computer or a LAN via Ethernet connection point.

If the customers want, they control the plasma filter unit by pressing any button on the control panel or automatically when the cutting starts.

Machine searches the plate, finds the Operation Zero position and calculates the Plate Angle automatically.

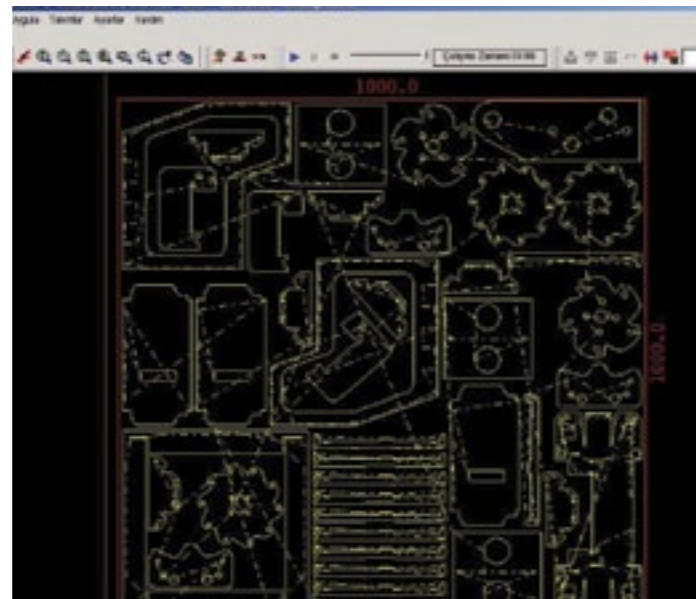

CAD Cam Software

Metalix software is available for easy programming and drawing of parts. It also easily and quickly converts DXF and DWG files to machine language for cutting.

The automatic nesting feature looks at the multiple parts to be cut from the sheet, and then organizes them on the sheet in the most efficient way. Lower material costs.



Fume Extraction System

During the thermal cutting process, a large amount of harmful dust particles are created. This dust is harmful to personnel, the environment, and the machines. Therefore it is important to use a filtration system for optimum extraction of these particles and provide a clean air working environment.



OXY Cut

Oxy-fuel cutting heads are available to allow the cutting of thicker mild steel.

Air Dryer

Plasma technology uses air for cutting and/or shield gas. This air must be clean, dry, and oil free. In this case an air dryer must be used.

THC Pendant Panel

A remote control pendant for Hypertherm THC (torch height control) Command System.

Longer Consumable Life

Patented LongLife technology significantly improves consumable life. Exceptional cutting speeds produce more finished parts per set of consumables. HyPerformance consumables are engineered for higher quality with lower cost.

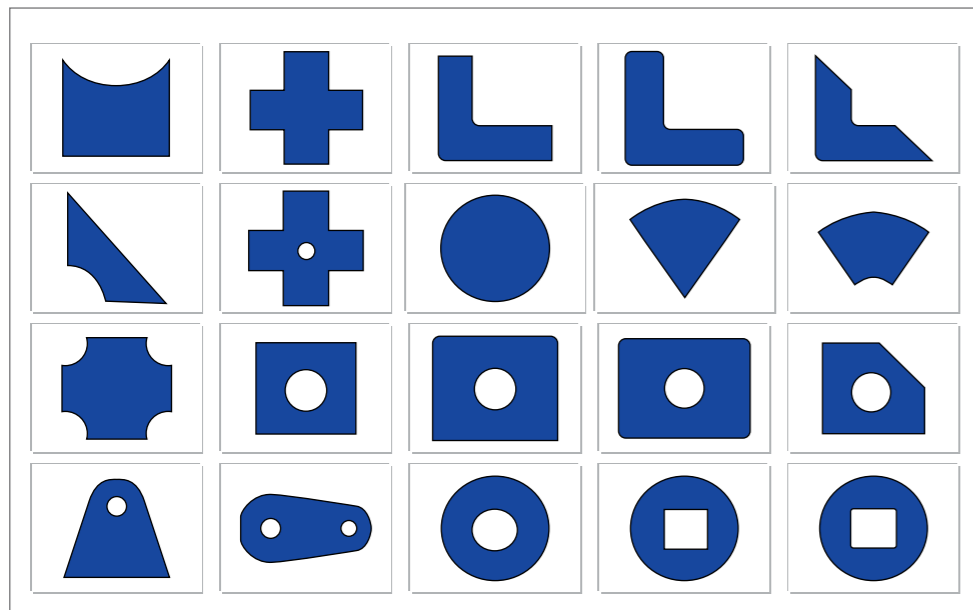

Cutting Tables

All cutting tables are partitioned in to different zones. Each zone is equipped with electro pneumatic switch which are automatically controlled by the CNC when the torch is cutting in that zone. This enhances exhaust capabilities and reduces the size requirement of the filtration system.

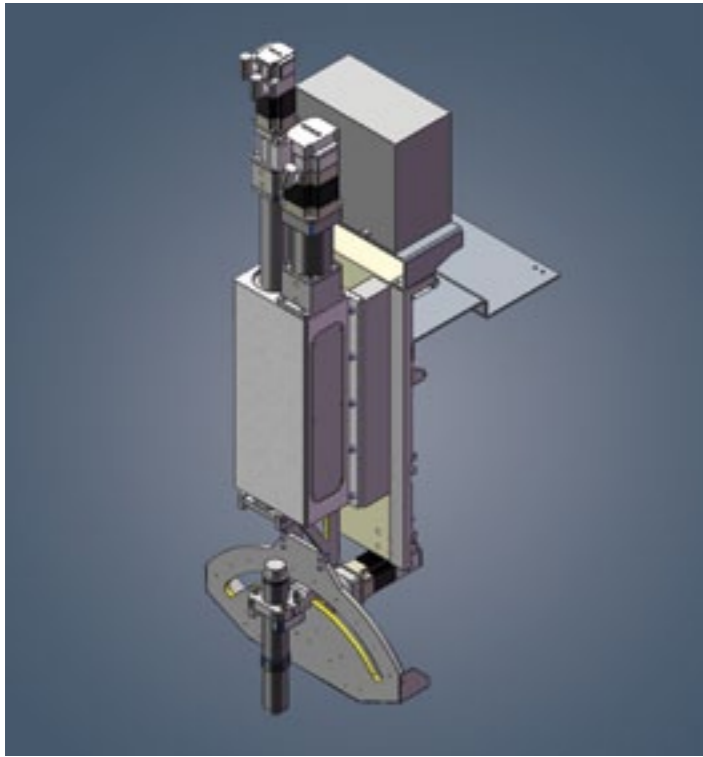

Plasma Beveling Head



Drilling Head



Plasma Cutting Machine with loading unloading system

PL & PL-C

STANDARD EQUIPMENTS

- Siemens 840 D-ISL CNC control Unit
- Solid & CNC machined steel frames
- Robust bridge
- CAD CAM Software with Auto nesting
- Cutting plate alignment function with Laser diode
- Plasma ignition consol
- Command Torch High Control (THC)
- Two side motion control system (low backlash reducers + rack / pinion)
- AC Digital Servomotors on axes
- Marking system
- CNC control outputs/inputs for filter unit
- Spare parts ,consumables starting kit
- High mechanical accuracy to +- 0,1 mm
- Axis positioning speed 35 m/min.
- Torch height control travel with ballscrew on dual linear guides
- Independent cutting tables
- Speed control device
- Table incl PL-C series
- Remote diagnostics via Ethernet
- Rack&Pinion with linear guide (PL-C Series)
- Thick slats on table
- Tables suitable for right suction
- Web cam for service

OPTIONAL EQUIPMENTS

- Table for PL series
- Hypertherm Plasma source
- Automatic gas consol
- Manuel gas consol
- Filter
- Plasma Torch brake away system
- Additional plasma torch (Plasma Torch, Torch High Control (THC), Ignition consol)
- Additional Oxy-fuel Torch (Oxy -fuel torch, Oxy torch high control, Oxy torch high sensor) (max. 2 oxy torch)
- Bridge preparation for additional torch (plazma or oxy)
- Manuel torch tilting system $\pm 45^\circ$
- CNC controlled torch tilting system $\pm 45^\circ$
- 3D Cutting & Rotator
- Safety light barrier
- Fault and Program end signal lamp
- Air dryer
- Arcglide THC Torch Height Control (instead of Command THC)
- Drilling Spindle
- Loading & Unloading systems
- Special applications
- Consumables

	A (mm.)	B (mm.)	C (mm.)	D (mm.)	E (mm.)	F (mm.)	G (mm.)	H (mm.)	WEIGHT (kg)
PL-C 1530	8200	4300	4650	2300	1920	938	3065	1580	5100
PL-C 2040	9950	4900	5650	2784	1928	931	4066	2068	5900
PL-C 2060	11700	4900	7650	2784	1928	931	6105	2068	7800
PL 20120	18250	6500	14200	4110	2200	700-750	12360	2100	12710
PL 2580	14250	7500	10200	5110	2200	700-750	8240	2600	10710
PL 25120	18250	7500	14200	5110	2200	700-750	12360	2600	14410
PL 25260	32250	7500	28200	5110	2200	700-750	26780	2600	22500
PL 3080	14250	7500	10200	5110	2200	700-750	8240	3100	11510
PL 30120	18250	7500	14200	5110	2200	700-750	12360	3100	15610
PL 30140	20250	7500	16200	5110	2200	700-750	14420	3100	17550
PL 3580	14250	8500	10200	6110	2200	700-750	8240	3600	12710
PL 35100	16250	8500	12200	6110	2200	700-750	10380	3600	15010
PL 35120	18250	8500	14200	6110	2200	700-750	12360	3600	17310
PL 35140	20250	8500	16200	6110	2200	700-750	14420	3600	19610
PL 4080	14250	8500	10200	6110	2200	700-750	8240	4200	15310
PL 40100	16250	8500	12200	6110	2200	700-750	10380	4200	18210
PL 40120	18250	8500	14200	6110	2200	700-750	12360	4200	21110
PL 40140	20250	8500	16200	6110	2200	700-750	14420	4200	24010
PL 50180	24250	9500	20200	6110	2200	700-750	18540	5200	30000
PL 60260	32250	10500	28200	7110	2200	700-750	26780	6200	48000

HPR Specifications	Unit	HPR130	HPR260	HPR400
Plasma power source		Hypertherm	Hypertherm	Hypertherm
Max High Quality Cutting capacity (MS) (edge start)	mm	38	38	80
Max High Quality Cutting capacity (MS) (pierce capacity)	mm	16	16	50
Maximum Positioning speed X / Y	m/min	35	35	35
Maximum Cutting speed	m/min.	12	12	12
Positioning accuracy	mm	+/-0.1	+/-0.1	+/-0.1
Repeatability	mm	0.1	0.1	0.1
Output current	A	130	130	400
Current regulation range	A	30-130	30-130	30-400
Gas console - automatic	-	O2,N2,H35, F5,Air	O2,N2,H35, F5,Air	O2,N2,H35, F5,Air
Cutting angle	degree	2 - 4	2 - 4	2 - 4
Plasma gas	-	O2,N2,H35, F5,Air	O2,N2,H35, F5,Air	O2,N2,H35, F5,Air
Plasma shield gas	-	O2,N2,Air, H35	O2,N2,Air, H35	O2,N2,Air, H35

PL-C

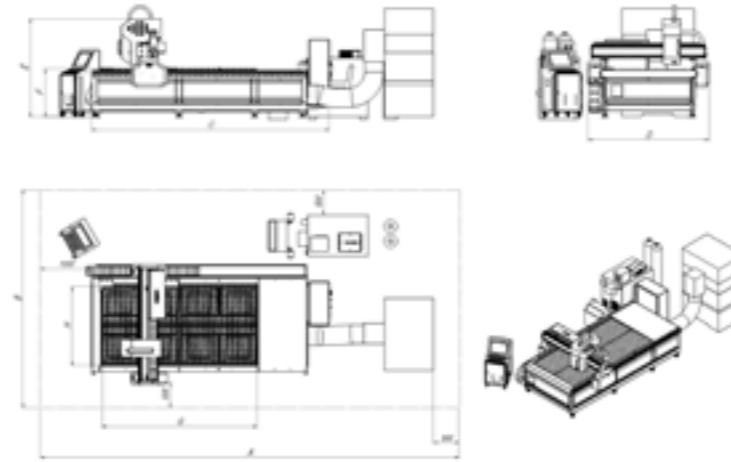

PL

